

AS3T040A120H

V_{DS}	1200 V
$R_{DS,on}$	38 m Ω
$I_D (T_C=25^\circ C)$	62 A
$T_{j,max}$	175 $^\circ C$

QSiC™ 1200V SiC MOSFET

Features

- High speed switching
 - Reliable body diode
 - All parts tested to greater than 1,400V
 - Avalanche tested to 330mJ
 - Driver source pin for gate driving
 - Qualified for Automotive Applications
- Product Validation according to AEC-Q101

Benefits

- Lower capacitance
- Higher system efficiency
- Easy to parallel
- Lower Switching Loss
- Longer creepage distance

Applications

- On board chargers
- High voltage DC/DC converters
- Motor drives
- Switch mode power supplies
- EV charging stations

Package

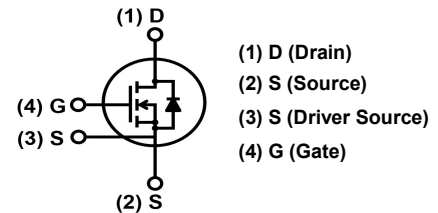

Part #	Package	Marking
AS3T040A120H	TO-247-4L	AS3T040A120H



Maximum Ratings, at $T_j=25^\circ C$, unless otherwise specified

Characteristics	Symbol	Conditions	Values	Unit
Drain-Source Voltage	V_{rated}	$V_{GS}=0V, I_{DS}=1\mu A$	1200	V
Continuous Drain Current	I_D	$T_C=25^\circ C, T_j=175^\circ C$	62	A
		$T_C=100^\circ C, T_j=175^\circ C$	44	
Pulsed Drain Current	$I_{D,pulse}^*$	$T_C=25^\circ C$	140	
Gate Source Voltage	V_{GSmax}		-8/22	V
	V_{GSop}	Recommended operational	-4.5/18	
Power Dissipation	P_{tot}	$T_C=25^\circ C$	246	W
Operating & Storage Temperature	$T_j, T_{storage}$	Continuous	-55...175	$^\circ C$
Single Pulse Avalanche Energy	E_{AS}	$L=1.0mH, I_{AS}=25.7A, V=50V$	330	mJ

Thermal Characteristics

Characteristics	Symbol	Conditions	Values			Unit
			min.	typ.	max.	
Thermal Resistance, Junction to Case	R_{thJC}		-	0.49	0.61	$^\circ C/W$
Thermal Resistance, Junction to Ambient	R_{thJA}		-	-	40.0	

* Pulse width is limited by $T_{j,max}$

Static Electrical Characteristics, at $T_j=25^\circ\text{C}$, unless otherwise specified

Characteristics	Symbol	Conditions	Values			Unit
			min.	typ.	max.	
Drain-Source Breakdown Voltage	BV_{DSS}	$I_{DS}=1\text{mA}$	1200	-	-	V
Zero Gate Voltage Drain Current	I_{DSS}	$V_{DS}=1200\text{V}, V_{GS}=0\text{V}$	-	0.1	1.0	μA
		$V_{DS}=1200\text{V}, V_{GS}=0\text{V}, T_j=175^\circ\text{C}$	-	1	-	
Gate-Source Leakage Current	I_{GSS+}	$V_{GS}=18\text{V}, V_{DS}=0\text{V}$	-	10	100	nA
	I_{GSS-}	$V_{GS}=-4.5\text{V}, V_{DS}=0\text{V}$	-	-10	-100	
Gate Threshold Voltage	$V_{GS(th)}$	$V_{GS}=V_{DS}, I_{DS}=10\text{mA}$	1.8	3.5	4	V
		$V_{GS}=V_{DS}, I_{DS}=10\text{mA}, T_j=125^\circ\text{C}$	-	2.7	-	
		$V_{GS}=V_{DS}, I_{DS}=10\text{mA}, T_j=175^\circ\text{C}$	-	2.5	-	
Drain-Source On-Resistance	$R_{DS(on)}$	$V_{GS}=18\text{V}, I_{DS}=20\text{A}$	-	38	52	m Ω
		$V_{GS}=18\text{V}, I_{DS}=20\text{A}, T_j=125^\circ\text{C}$	-	50	-	
		$V_{GS}=18\text{V}, I_{DS}=20\text{A}, T_j=175^\circ\text{C}$	-	63	-	
Transconductance	g_{fs}	$V_{DS}=20\text{V}, I_{DS}=20\text{A}$	-	12	-	S
Gate Input Resistance	R_G	$f=1\text{MHz}, V_{AC}=25\text{mV}, \text{D-S Short}$	-	2.9	-	Ω

AC Electrical Characteristics, at $T_j=25^\circ\text{C}$, unless otherwise specified

Characteristics	Symbol	Conditions	Values			Unit
			min.	typ.	max.	
Input Capacitance	C_{ISS}	$V_{GS}=0\text{V},$ $V_{DS}=1000\text{V},$ $f=200\text{kHz}, V_{AC}=25\text{mV}$	-	2803	-	pF
Output Capacitance	C_{OSS}		-	97	-	
Reverse Transfer Capacitance	C_{RSS}		-	9	-	
Coss Stored Energy	E_{OSS}		-	56	-	
Turn-On Switching Energy	E_{ON}	$V_{DD}=800\text{V}, I_{DS}=40\text{A},$ $R_{G(ext)}=2.5\Omega,$	-	666	-	μJ
Turn-Off Switching Energy	E_{OFF}	$V_{GS}=-4.5/+18\text{V}, L=273\mu\text{H},$	-	140	-	
Total Switching Energy	E_{TOT}	FWD=AS3T040A120H	-	806	-	
Turn-On Switching Energy	E_{ON}	$V_{DD}=800\text{V}, I_{DS}=40\text{A},$ $R_{G(ext)}=2.5\Omega,$	-	558	-	μJ
Turn-Off Switching Energy	E_{OFF}	$V_{GS}=-4.5/+18\text{V}, L=273\mu\text{H},$	-	139	-	
Total Switching Energy	E_{TOT}	FWD=GP3D020A120B	-	697	-	
Turn-On Delay Time	$t_{D(on)}$	$V_{DD}=800\text{V}, I_{DS}=40\text{A},$	-	17	-	ns
Rise Time	t_R	$R_{G(ext)}=2.5\Omega,$	-	8	-	
Turn-Off Delay Time	$t_{D(off)}$	$V_{GS}=-4.5/+18\text{V}, L=273\mu\text{H},$	-	31	-	
Fall Time	t_F	FWD=AS3T040A120H	-	10	-	
Total Gate Charge	Q_G	$V_{DD}=800\text{V}, I_{DS}=40\text{A},$ $V_{GS}=-4.5/+18\text{V}$	-	108	-	nC
Gate to Source Charge	Q_{GS}		-	43	-	
Gate to Drain Charge	Q_{GD}		-	28	-	

Body Diode Characteristics, at $T_j=25^\circ\text{C}$, unless otherwise specified

Characteristics	Symbol	Conditions	Values			Unit
			min.	typ.	max.	
Max Continuous Diode Fwd Current	I_S	$V_{GS}=-5\text{V}, T_C=25^\circ\text{C}$	-	-	55	A
Diode Forward Voltage	V_{SD}	$V_{GS}=-5\text{V}, I_{SD}=10\text{A}$	-	3.7	-	V
Reverse Recovery Time	t_{RR}	$I_{SD}=40\text{A}, V_R=800\text{V},$ $V_{GS}=-4.5/+18\text{V}, di_F/dt=7.8\text{A/ns}$	-	11	-	ns
Reverse Recovery Charge	Q_{RR}		-	323	-	nC
Peak Reverse Recovery Current	I_{RRM}		-	50	-	A

Typical Performance

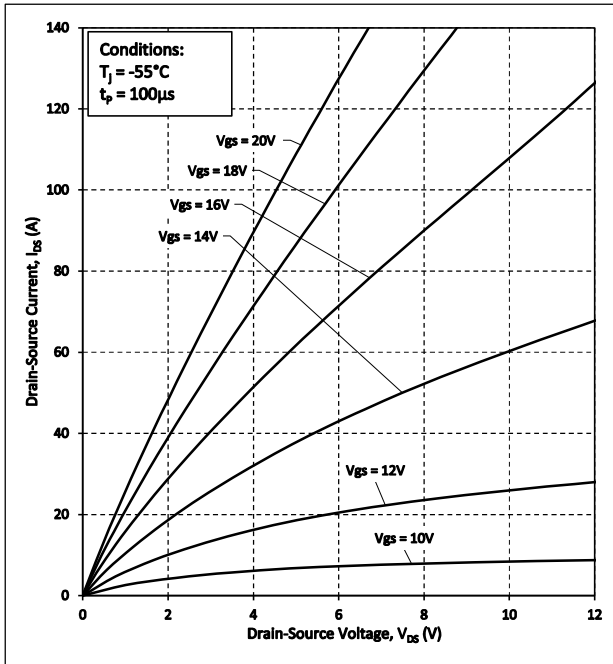

Figure 1. Output Characteristics $T_j = -55^\circ\text{C}$

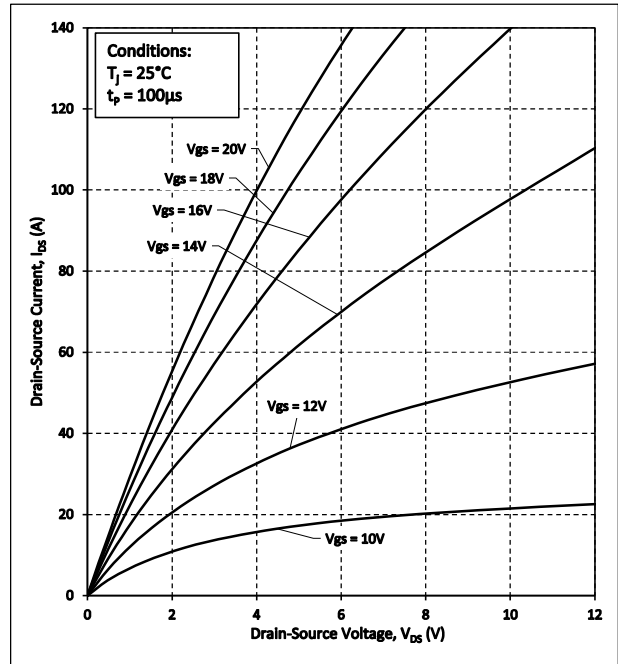

Figure 2. Output Characteristics $T_j = 25^\circ\text{C}$

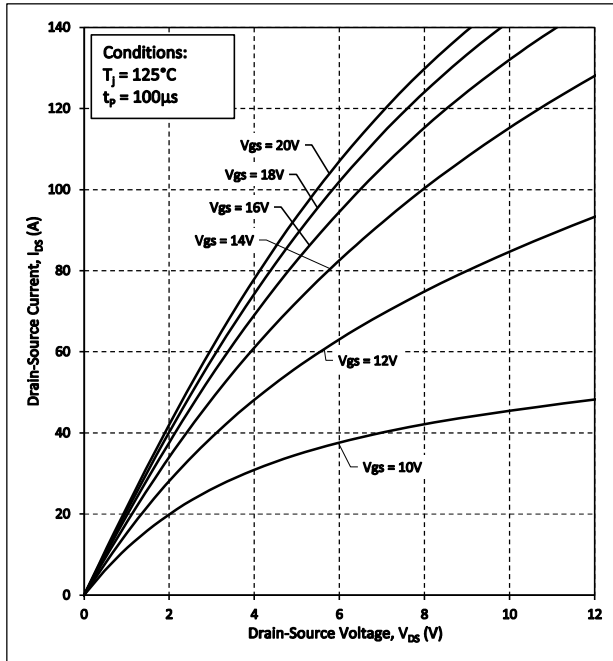

Figure 3. Output Characteristics $T_j = 125^\circ\text{C}$

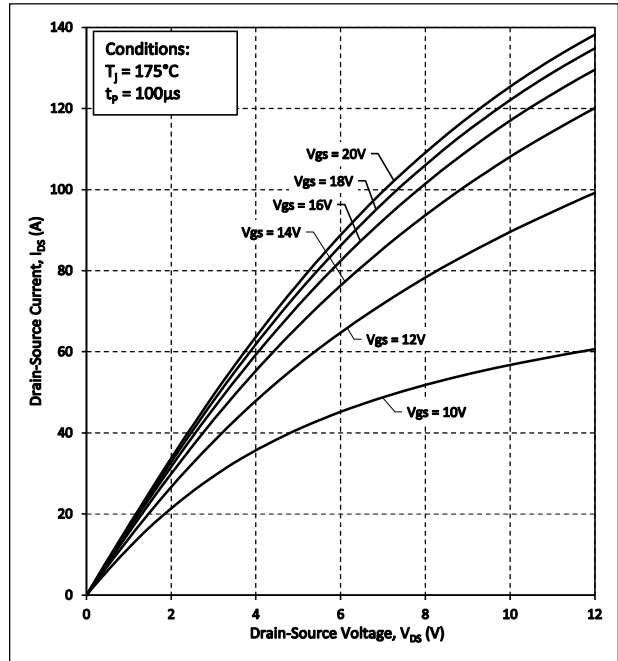

Figure 4. Output Characteristics $T_j = 175^\circ\text{C}$

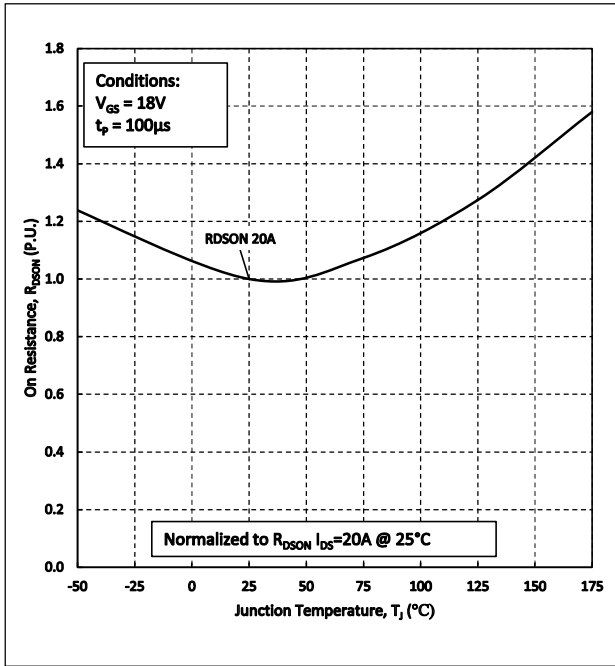

Figure 5. Normalized On-Resistance vs. Temperature

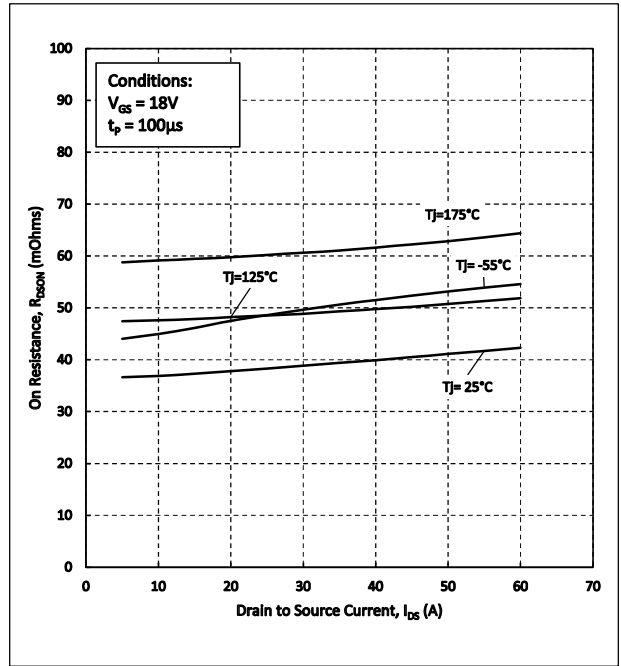

Figure 6. On-Resistance vs. Drain Current For Various Temperature

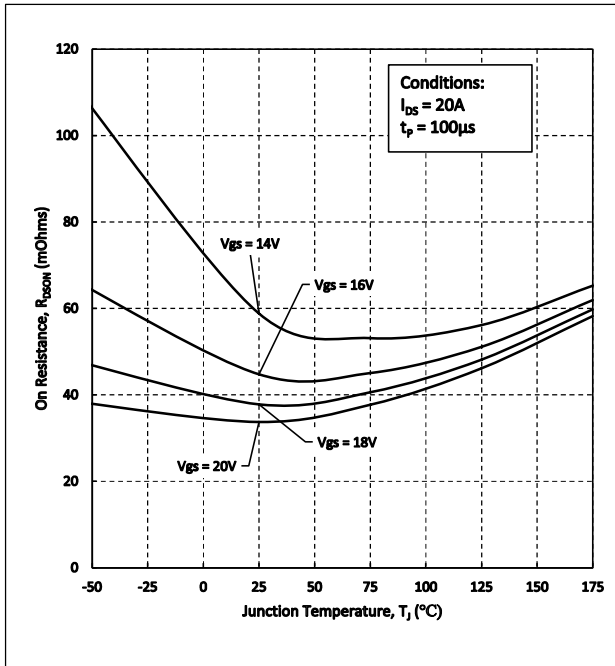

Figure 7. On-Resistance vs. Temperature For Various Gate Voltages

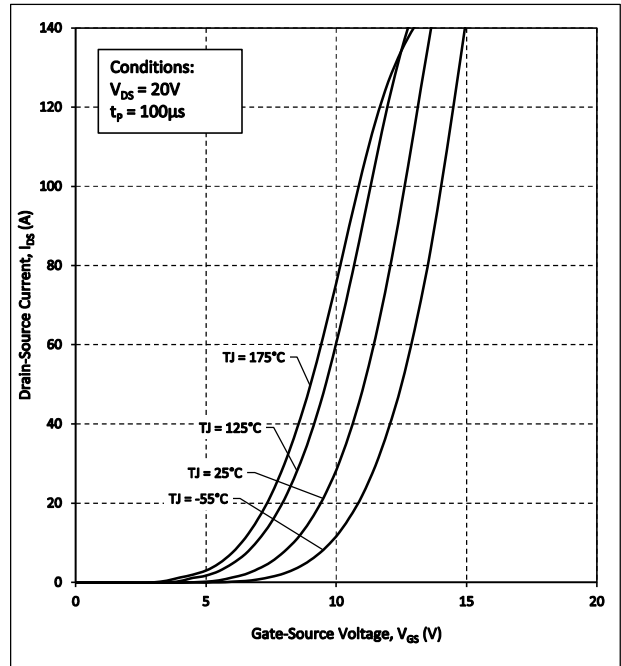

Figure 8. Transfer Characteristic for Various Junction Temperatures

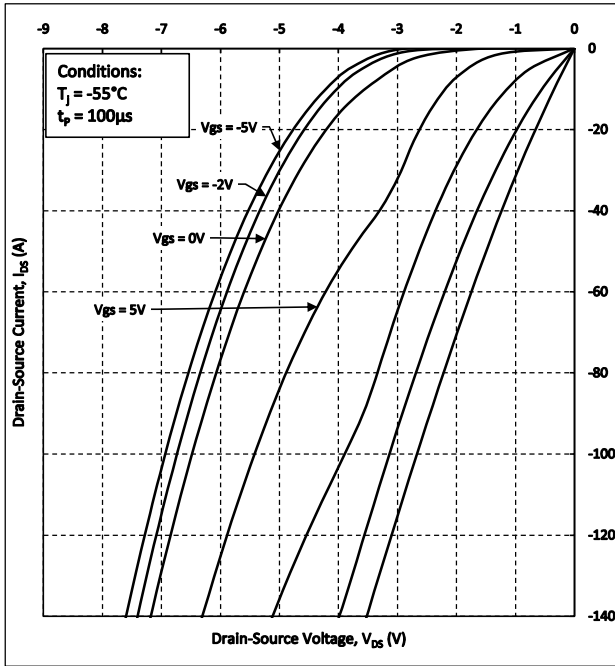

Figure 9. Body Diode Characteristics at $T_j = -55^\circ\text{C}$

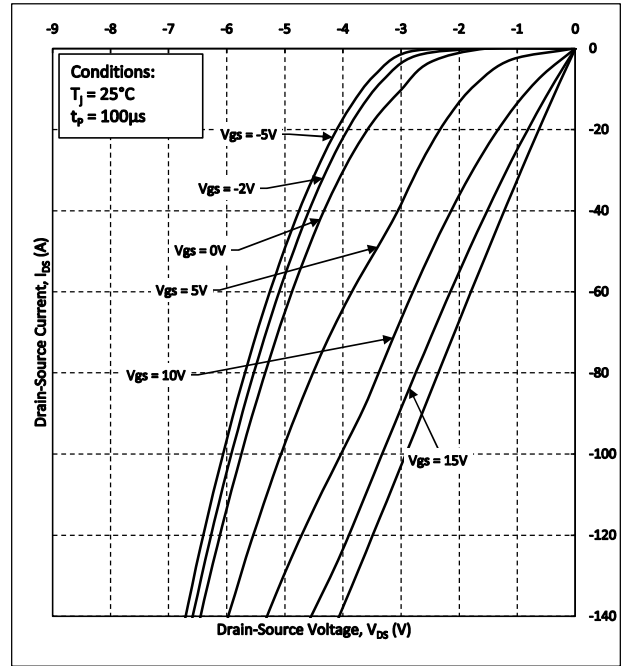

Figure 10. Body Diode Characteristics at $T_j = 25^\circ\text{C}$

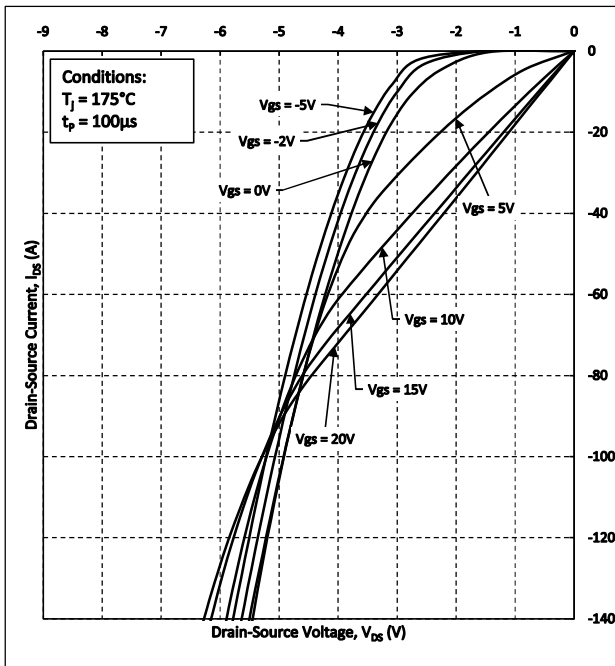

Figure 11. Body Diode Characteristics at $T_j = 175^\circ\text{C}$

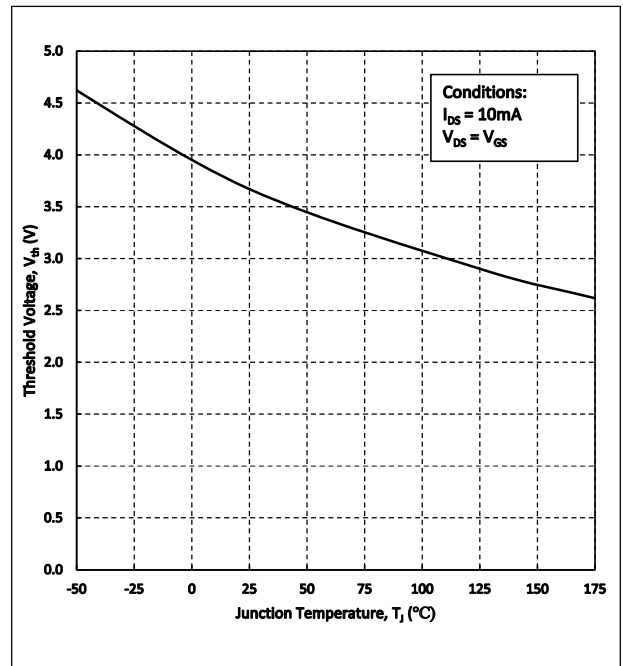

Figure 12. Threshold Voltage vs. Temperature

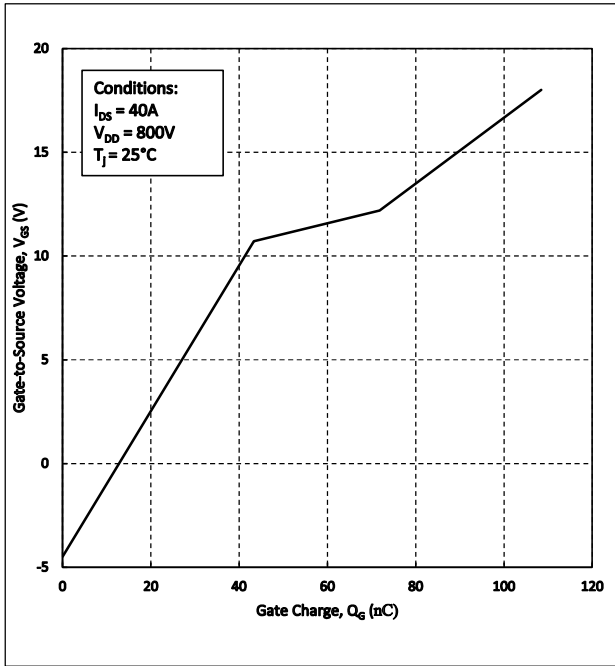

Figure 13. Gate Charge Characteristics

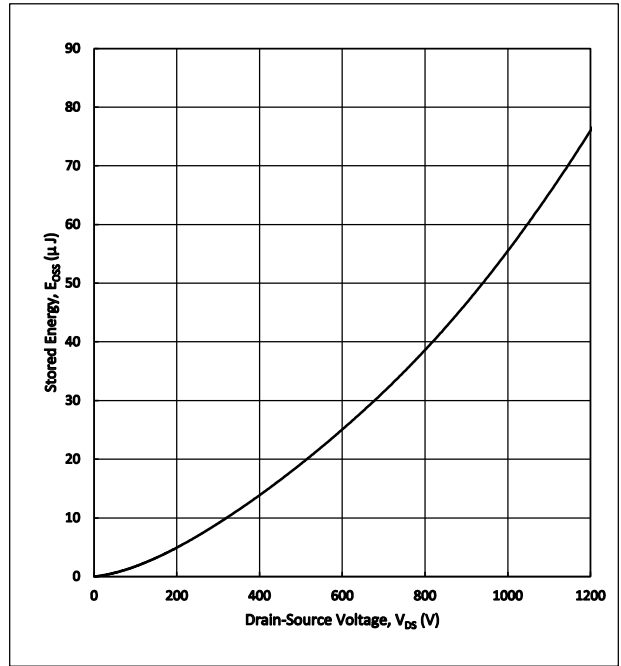

Figure 14. Output Capacitor Stored Energy

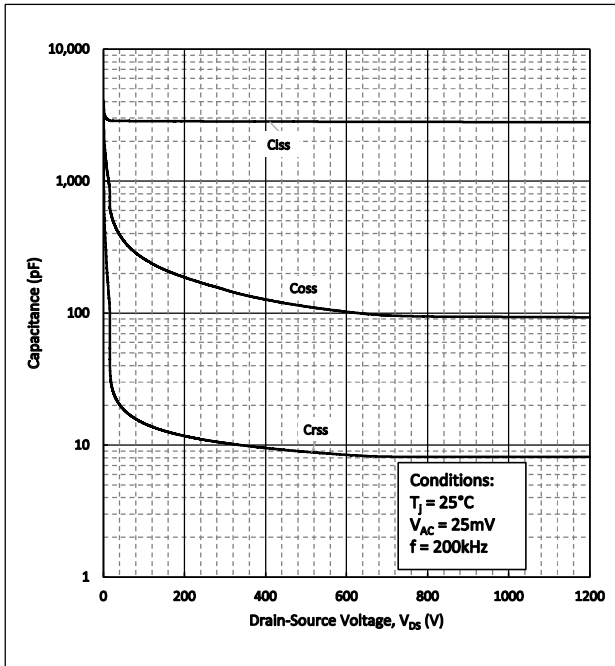

Figure 15. Capacitance vs Drain-Source Voltage

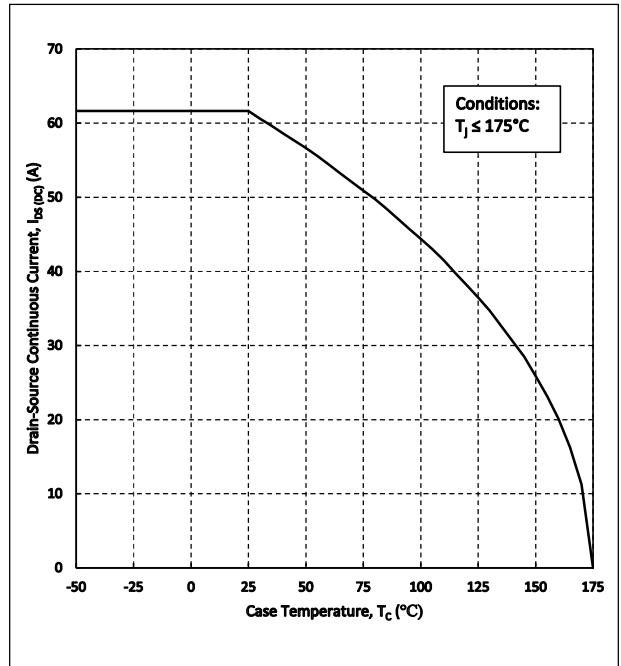

Figure 16. Continuous Drain Current Derating vs. Case Temperature

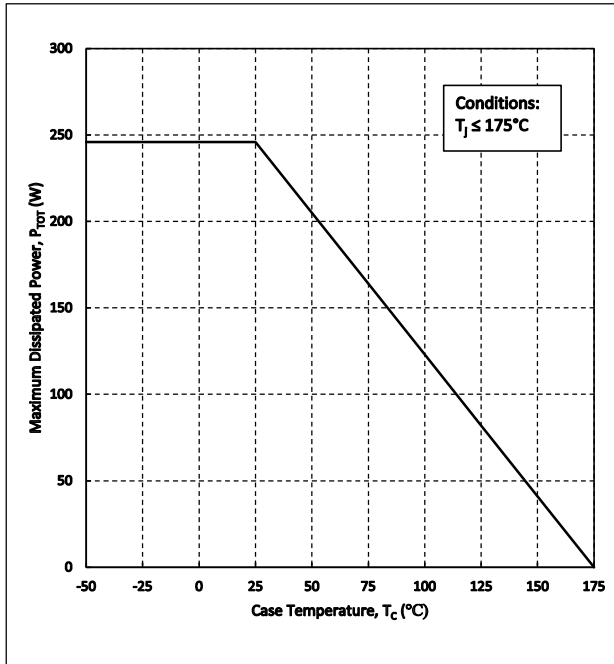

Figure 17. Maximum Power Dissipation Derating vs Case Temperature

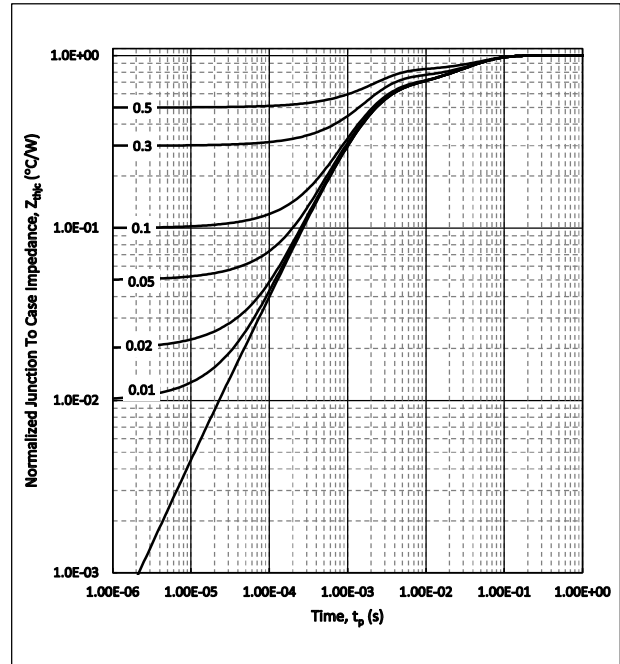

Figure 18. Transient Thermal impedance (Junction to Case)

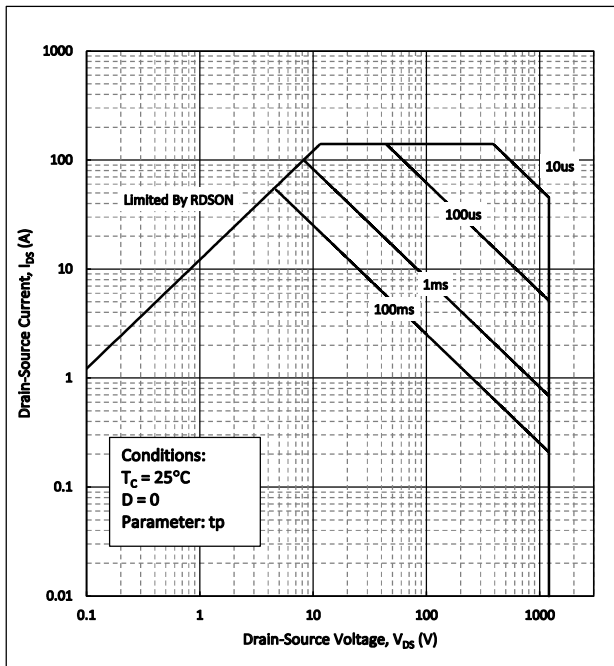

Figure 19. Safe Operating Area

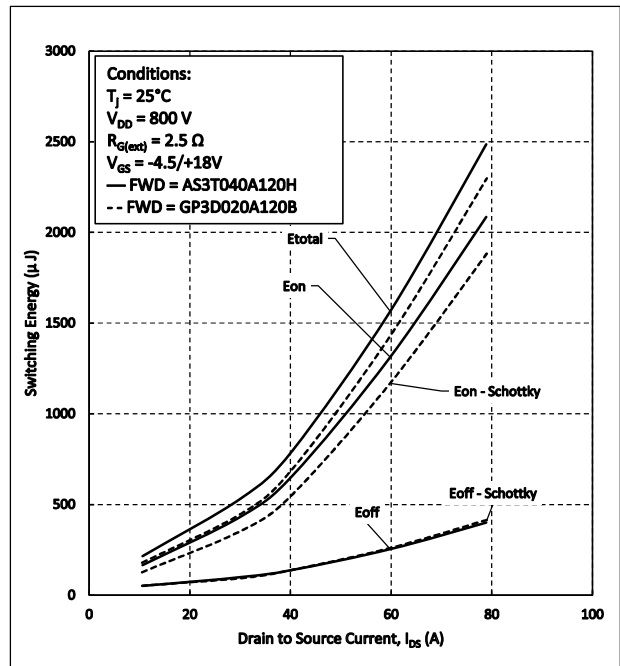

Figure 20. Clamped Inductive Switching Energy vs. Drain Current

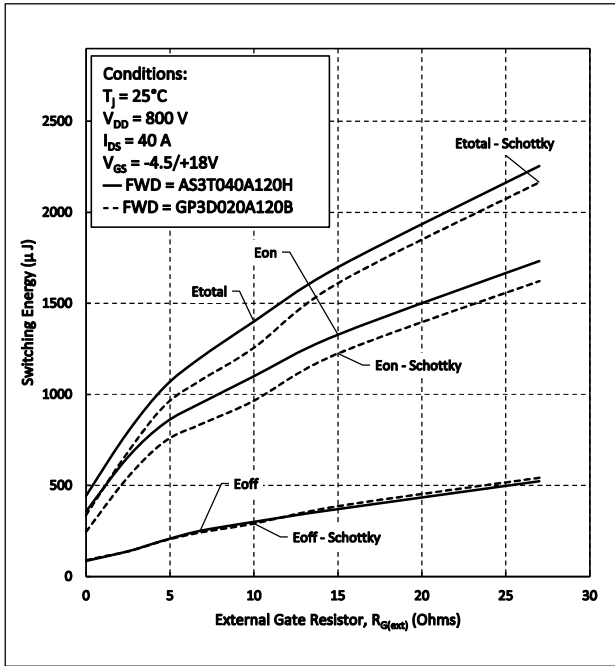

Figure 21. Clamped Inductive Switching Energy vs. $R_{G(ext)}$

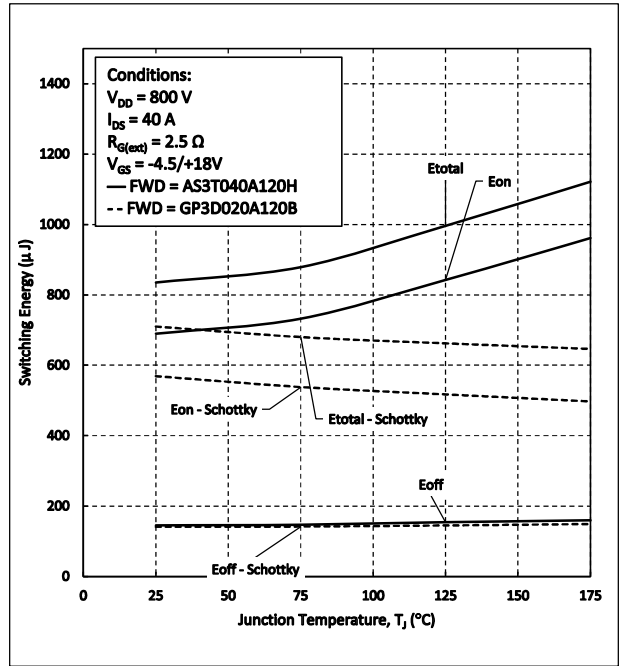

Figure 22. Clamped Inductive Switching Energy vs. Temperature

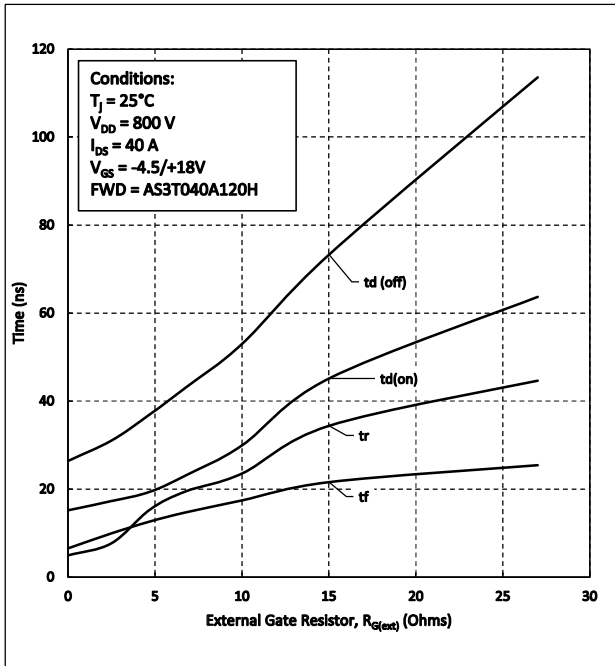

Figure 23. Switching Times vs $R_{G(ext)}$

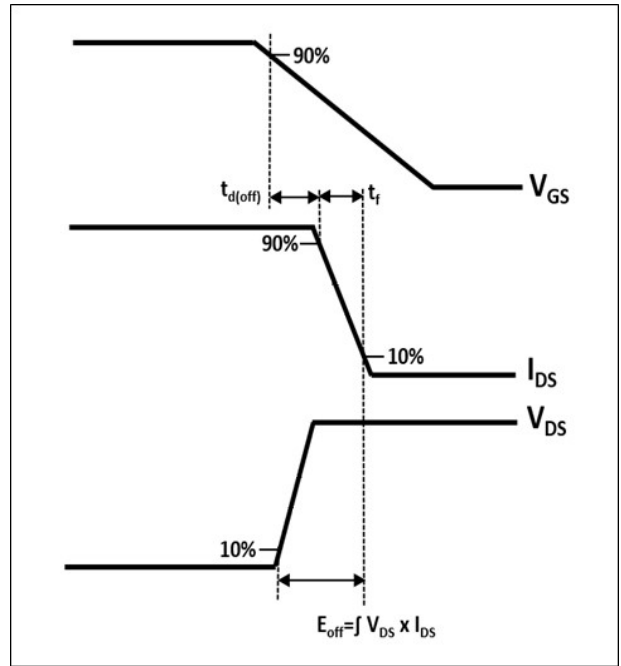

Figure 24. Turn-off Transient Definitions

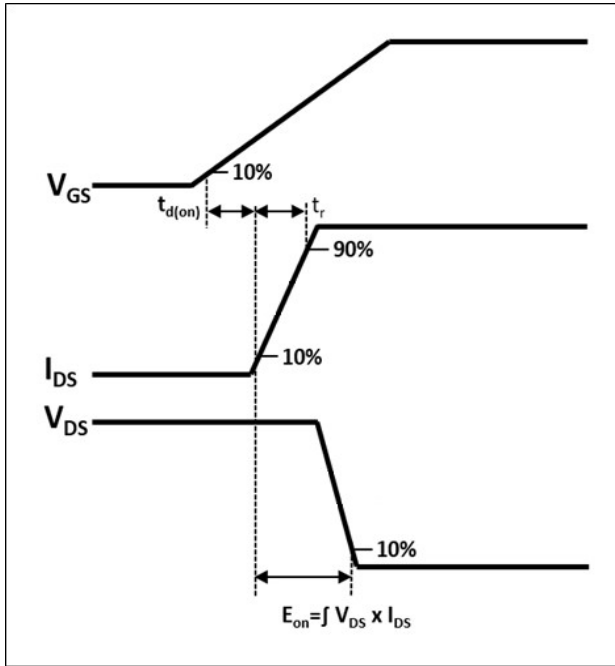

Figure 25. Turn-on Transient Definitions

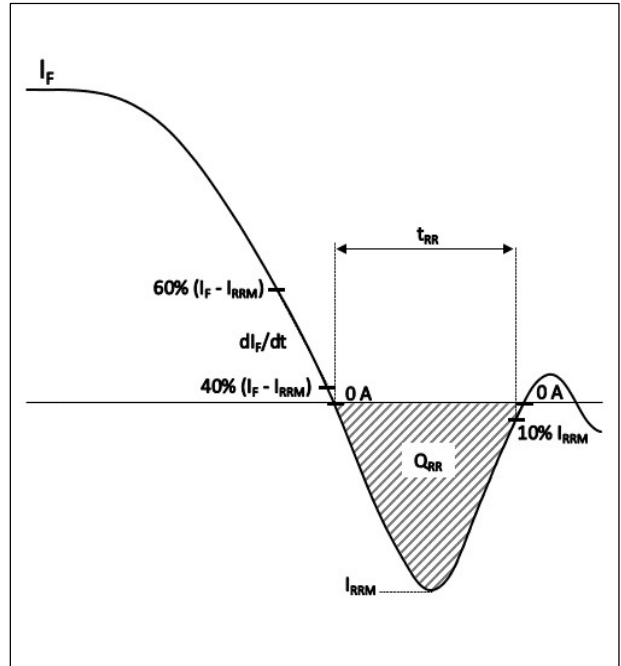
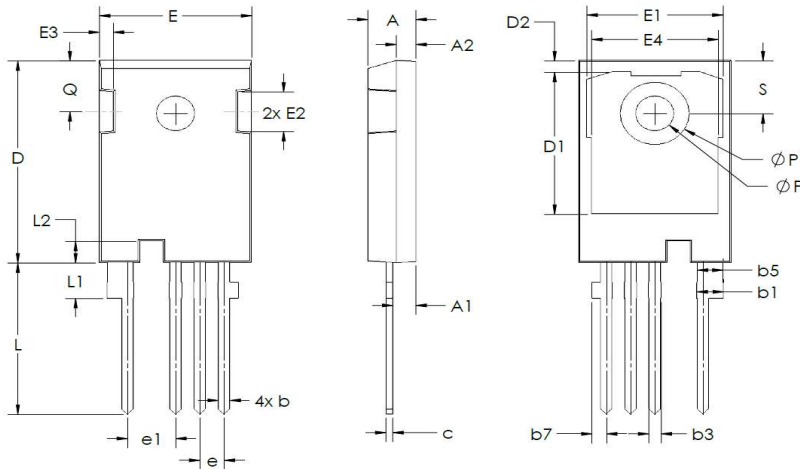

Figure 26. Reverse Recovery Definitions

Package Dimensions TO-247-4L



Sym	Millimeters		Inches	
	Min	Max	Min	Max
A	4.83	5.21	0.190	0.205
A1	2.29	2.54	0.090	0.100
A2	1.91	2.16	0.075	0.085
b	1.07	1.33	0.042	0.052
b1	2.39	2.94	0.094	0.116
b3	1.07	1.60	0.042	0.063
b5	2.39	2.69	0.094	0.106
b7	1.30	1.70	0.051	0.067
c	0.55	0.68	0.022	0.027
c1	0.55	0.65	0.022	0.026
D	23.30	23.60	0.917	0.929
D1	16.25	17.65	0.640	0.695
D2	0.95	1.25	0.037	0.049
E	15.75	16.13	0.620	0.635
E1	13.10	14.15	0.516	0.557
E2	3.68	5.10	0.145	0.201
E3	1.00	1.90	0.039	0.075
E4	12.38	13.43	0.487	0.529
e	2.54 BSC		0.100 BSC	
e1	5.08 BSC		0.200 BSC	
L	17.31	17.82	0.681	0.702
L1	3.97	4.37	0.156	0.172
L2	2.35	2.65	0.093	0.104
ØP	3.51	3.65	0.138	0.144
ØP1	7.19 REF		0.283 REF	
Q	5.49	6.00	0.216	0.236
S	6.04	6.30	0.238	0.248

Warnings**AEC Qualification**

Except as otherwise explicitly approved by SemiQ, Inc. in a written document signed by authorized representatives of SemiQ, SemiQ products may not be used in any applications where a failure of the product or any consequences of the use thereof can reasonably be expected to result in personal injury.

Notes**RoHS Compliance**

The levels of RoHS restricted materials in this product are below the maximum concentration values (also referred to as the threshold limits) permitted for such substances, or are used in an exempted application, in accordance with EU Directive 2011/65/EC (RoHS2), as implemented March, 2013. RoHS Declarations for this product can be obtained from the Product Documentation sections of www.SemiQ.com.

REACH Compliance

REACH substances of high concern (SVHC) information is available for this product. Since the European Chemicals Agency (ECHA) has published notice of their intent to frequently revise the SVHC listing for the foreseeable future, please contact our office at SemiQ Headquarters in Lake Forest, California to insure you get the most up-to-date REACH SVHC Declaration. REACH banned substance information (REACH Article 67) is also available upon request. SemiQ Inc., reserves the right to make changes to the product specifications and data in this document without notice. SemiQ products are sold pursuant to SemiQ's terms and conditions of sale in place at the time of order acknowledgement.

This product has not been designed or tested for use in, and is not intended for use in, applications implanted into the human body nor in applications in which failure of the product could lead to death, personal injury or property damage, including but not limited to equipment used in the operation of nuclear facilities, life-support machines, cardiac defibrillators or similar emergency medical equipment, aircraft navigation or communication or control systems, or air traffic control.

SemiQ makes no warranty, representation or guarantee regarding the suitability of its products for any particular purpose, nor does SemiQ assume any liability arising out of the application or use of any product or circuit, and specifically disclaims any and all liability, including without limitation special, consequential or incidental damages. Buyer is responsible for its products and applications using SemiQ products.

To obtain additional technical information or to place an order for this product, please contact us. The information in this datasheet is provided by SemiQ.